

SmartCooler®

DATASHEET

cooler than smart

LFM3592: SmartCooler® LNB fan 92x92x25mm

Picture similar to original product:



Drawing similar to original product:

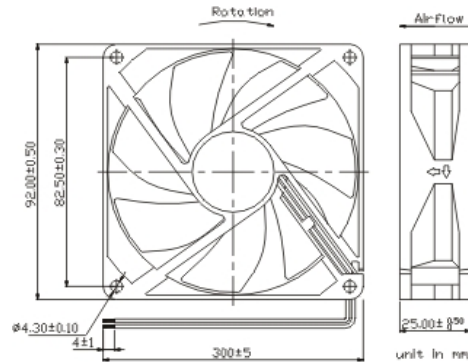

Description:

92x25mm SmartCooler® LNB fan made of PBT + 15-30% GF UL94V-0 with very low noise features, minimum vibration and minimum pulsing noise. Rotation from 900 up to 3.700 R.P.M.. Airflow from 33.5 – 136.5m³/h. Noise from 9-45dBA.

Product data:

Size (LxWxH):	92x92x25mm	Bearing:	Liquid nano bearing
Hole distance:	81.5mm	Weight:	89 gramm
Hole diameter:	4.3mm	Frame:	8-Hole Frame
Cable:	500mm, UL 1007 AWG 26	Connector:	3-Pin, 4-Pin connector 2.54mm
Optional features:	Speed signal	Autorestart	PWM-Signal

Function data:

(V)= 4-Hole, (P)= PWM

Version:	L	E	M	S	H	U	X
R.P.M. +/- 10%:	900	1.200	1.700	2.200	2.700	3.200	3.700
Airflow m³/h:	33.50	45.00	63.00	81.50	100.00	118.50	136.50
Airflow cfm:	19.70	26.47	37.05	47.94	58.82	69.70	80.29
Aqmm.	0.445	1.097	1.750	2.435	3.663	4.892	7.150
Noise dbA:	9.000	15.00	22.00	28.00	32.00	38.00	45.00

Electrical data:

Rated current Amp:	0.08A	0.09A	0.10A	0.15A	0.20A	0.25A	0.40A
Rated Power Watt:	0.96W	1.08W	1.20W	1.80W	2.40W	3.00W	4.80W
Starting voltage:	5.00V	5.00V	5.00V	5.00V	5.00V	5.00V	5.00V
Operation voltage:	12.0V	12.0V	12.0V	12.0V	12.0V	12.0V	12.0V

Physical boundaries:

MTBF time about:	<= H = 150K/h, > H = 120K/h	Drop test:	Withstands free body drop of 30cm on a 1m² wooden table with a thickness of 10mm.
Max.environment°C:	70°C	Vib. test:	1.000 R.P.M at 2mm amplitude for 30 Min.

Item:

Safety standards:

Produced after following standards:

CE, TÜV, UL, UR

Item:

Packing:

Size retail Box (LxWxH):

195x150x25mm

Shipping qty. carton:

100 pcs.

Note:

Revision:

Revision: 3.3

Last change: 2008-08-28

SmartCooler GmbH accept no liability for accuracy of the above given information.
Technical changes are subject to alteration.

SmartCooler GmbH - Bernardstraße 5-7 - D-63179 Obertshausen, Germany - EUROPE - Fon +49/6104/600 47-0 - Fax +49/6104/600 47-99
Geschäftsführer - Reinhard Bormuth - Handelsregister Offenbach HRB 11467 - VAT-No.: DE114191179
Internet: <http://www.smartcooler.de> - E-Mail: support@smartcooler.de